

ENGINE POWERED ARTICULATING BOOM LIFTS

AB25J (AB810J)

Compliant with CE/AS/EAC standards

PRODUCT HIGHLIGHTS

Precision Performance

- 3 joysticks with variable proportional control, accuracy in reaching the operation target

Intelligent Maintenance

- Industry leading 7" screen displays faults and status information, for easy reference, reducing service technician assistance. Workers can complete tasks under the remote guidance of qualified service technicians. Convenient for fleet managers to quickly access live machine and maintenance information

Reliable

- "Up right" with hydraulic leveling, the secondary boom extension and lift are hydraulic interlocked

Operating Efficiency

- The working platform can be lifted and lowered to any position without the need to operate the secondary boom



Standard Features

Oscillating function	7-in display screen	4WD(2WD) × 2WS
Proportional control with 3 joysticks	Automotive-grade sleeves for all pipes	4-wheel brake
Hydraulic platform leveling	160° Platform rotation	Weighing system
Tilt protection system	Max tilt rating to 5°	Telematics-ready connector
Flashing beacon	White noise alarm	Half mesh (For platform with swinging gate)
Secondary guarding device	Battery isolator	2.44 m(8') platform with swing gate
Fault diagnosis system	Non-marking tires	

Options & Accessories

AC power to platform	Glazier kit (For platform with swinging gate)	
1.83 m (8') platform with swinging gate		
1.45 m (4'9") platform		
Platform work light		

SINOBOOM™

PARTNERS IN ACCESS™

SINOBOOM.COM | SALES@SINOBOOM.COM
32-34 Marni Street, Dandenong South, VIC Australia 3175

ENGINE POWERED ARTICULATING BOOM LIFTS

AB18J (AB600J)

Compliant with CE/AS/EAC standards

Model	AB25J (AB810J)
Dimensions	
Max Platform Height	24.6 m (80'9")
Max Working Height	26.6 m (87'3")
Max Horizontal Reach	16.1 m (52'10")
Max Up and Over Clearance	9.4 m (30'10")
A Stowed Length	11.51 m (37'9")
B Stowed Width	2.49 m (8'2")
C Stowed Height	3.2 m (10'6")
Stowed Length (Transport)	11.51 m (37'9")
Stowed Width (Transport)	2.49 m (8'2")
Stowed Height (Transport)	3.2 m (10'6")
D Wheelbase	3.05 m (10')
Ground Clearance	0.39 m (15.4")
Platform Size (L×W×H)	2.44×0.91×1.1 m (8'×3'×3'7")
Performance	
Max Platform Capacity	230 kg (507 lbs)
Max Platform Occupants	2 Persons
Drive Speed (Stowed)	0~4.4 km/h (0~2.7 mph)
Drive Speed (Raised)	0~1.1 km/h (0~0.7 mph)
Gradeability	30% (2WD) / 40% (4WD)
Turntable Rotation	360°/Continuous
Platform Rotation	160°
Tilt Rating	5°
Turning Radius (Inside/Outside)	3.0 m/6.33 m (9'10"/20'9")
Turntable Tail-Swing	1 m (3'3")
Max Allowable Side Force	400 N (90 lbf)
Max Allowable Wind Speed	12.5 m/s (28 mph)
Tire Spec/Type	385/65-22.5 (Foam-filled)
Power	
Drive × Steer	4WD (2WD) × 2WS
Engine	54 kW/2400 rpm/QSF2.8t3TC72/ Cummins /China T3, EU Stage 3A
Hydraulic Tank Capacity	180 L (39.6 gal(UK)/47.6 gal(US))
Diesel Tank Capacity	140 L (30.8 gal(UK)/37.2 gal(US))
System Voltage	12 VDC
Weight	17,150 kg (37,809lbs) 4WD

Standards Compliance

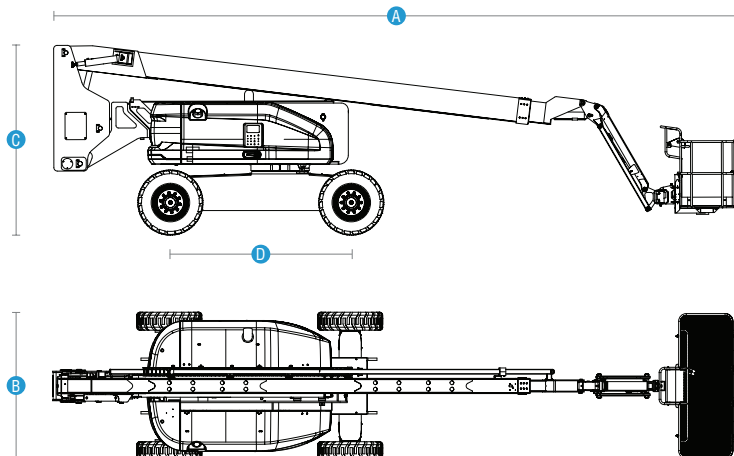

CE/AS/EAC

